

ASSEMBLING  
AND USING  
YOUR . . . . .

**Heathkit**

HEATHKIT  
MODEL QM-1  
Q-METER

595-52

**HEATH COMPANY**

BENTON HARBOR,  
MICHIGAN

PRICE \$1.00

THE WORLD'S *Finest* TEST EQUIPMENT IN KIT FORM

# HEATHKIT MODEL QM-1 Q-METER

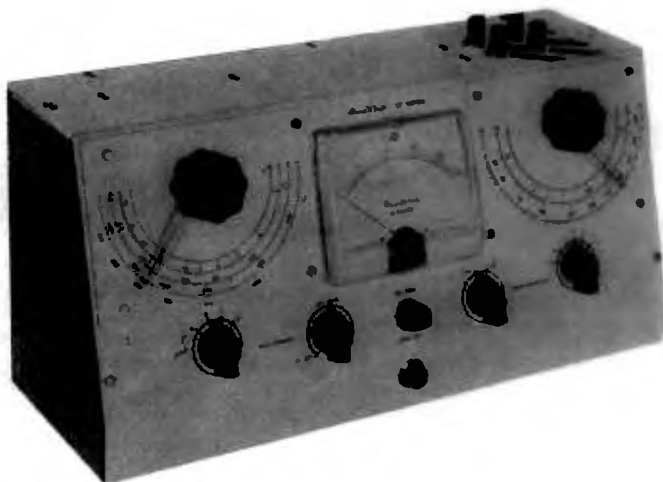

## SPECIFICATIONS

|  |                                    |
|--|------------------------------------|
| Power Requirements . . . . .             | 115 volts AC 50/60 cycles 30 watts |
| Tube Complement. . . . .                 | 1 - 12AT7 Oscillator               |
| . . . . .                                | 1 - 6AL5 VTVM diode                |
| . . . . .                                | 1 - 12AU7 VTVM amplifier           |
| . . . . .                                | 1 - OD3/VR150 Regulator            |
| . . . . .                                | 1 - 6X5 Rectifier                  |
| Frequency Range . . . . .                | 150 KC - 18 MC                     |
| Inductance Scale Range . . . . .         | 1 micro H. - 10 milli H.           |
| Actual Capacity Scale Range . . . . .    | 40 MMF - 450 MMF                   |
| Effective Capacity Scale Range . . . . . | 40 MMF - 400 MMF                   |
| Vernier Capacity Scale Range . . . . .   | -3 MMF - +3 MMF                    |
| "Q" Scale Range. . . . .                 | 250 Full scale x1 or x2            |
| Dimensions . . . . .                     | 6" high x 17" wide x 6" deep       |

# ASSEMBLY AND OPERATION OF THE HEATHKIT MODEL QM-1 Q-METER

The Heathkit Q Meter is a device of particular value in work with resonant circuits within the frequency and capacity ranges of the instrument.

It enables the user to measure the performance of such circuits and their component parts at the operating frequency and thus makes it possible to predict their operation in actual use.

The instrument is designed for simplicity both in construction and operation. But despite its simplicity, it is capable of excellent performance if properly constructed and intelligently used. Care used in the assembly will reward the builder through years of reliable service. Maximum results will be obtained by following the information given in this manual. It is, therefore, suggested that you take a few minutes now and read the entire manual, or at least the parts pertaining to the assembly and testing before any work is started.

Large pictorial diagrams are furnished and should be attached above the work space for your convenience. These pictorials are duplicated in a smaller size in this manual. The large prints may be discarded after the instrument is completed, but the manual should be retained in your files for future reference.

Unpack the kit carefully and check each part against the parts list. In doing this, you will become acquainted with each part. Refer to the charts and other information on the inside covers of this manual to help you identify any parts about which there may be a question. Make sure that all parts have been removed from the packaging material before it is thrown out. If a shortage is found in checking the parts, please notify us promptly and return the inspection slip with your letter to us. Hardware items are counted by weight, and if a few are missing, please obtain them locally if at all possible.

Resistors and controls generally have a tolerance rating of plus or minus 20% unless otherwise stated in the parts list. Thus a 10,000 ohm resistor may test anywhere from 8,000 ohms to 12,000 ohms. The tolerance on condensers is frequently even greater. This Heathkit is designed to accommodate such variations.

Small changes in parts may be made by the Heath Company. Such changes will not adversely affect the operation of the instrument, and will only be made to insure a minimum delay in filling your order.

Read the note on soldering on the inside back cover. Use only good quality rosin core radio type solder. Pastes or acids, while making soldering even easier, do not result in a joint satisfactory for radio work. Their cleaning action is based on a corroding effect, even if they are called "non-corrosive." They are very difficult to remove completely after the joint is made, and even a minute quantity left behind combines with moisture in the air to form a highly corrosive and conductive product. Thus weeks or months later the continued corrosion may "eat up" the wire or the joint causing failure through open circuits, or the conduction through the growing deposit may cause sufficient leakage to prevent proper operation.

**NOTE: All guarantees are voided and we will not repair or service instruments in which acid core solder or pastes are used. (When in doubt about solder, it is recommended that a new roll plainly marked "Rosin Core Radio Solder" be purchased.)**

## CONSTRUCTION

Many components are supplied by the manufacturers with leads that are longer than the particular application requires. Of course, all excess lead lengths should be removed so as to permit neat and direct installation of the components involved. Following this procedure will very definitely result in superior operation of the instrument and will afford you a sense of satisfaction and pride in having constructed a neat and professional appearing instrument.

Whenever necessary, use spaghetti or insulated sleeving over bare wires on condensers or resistors to prevent the leads from accidentally touching adjacent terminals, wires or metal parts.

Assemble the generator sub-chassis, the "Q" sub-chassis, the main chassis and the panel separately. Wire the first three parts as far as possible, then mount both sub-chassis on the main chassis and complete the wiring between these parts. Attach the panel to the chassis and complete the wiring.

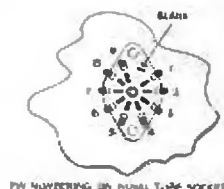
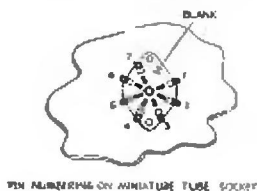
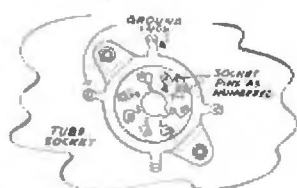

**Note:** Make sure the miniature and noval tube sockets are free from obstructions before inserting the tubes. These small tubes are fairly fragile and broken tubes are not covered by any guarantee.

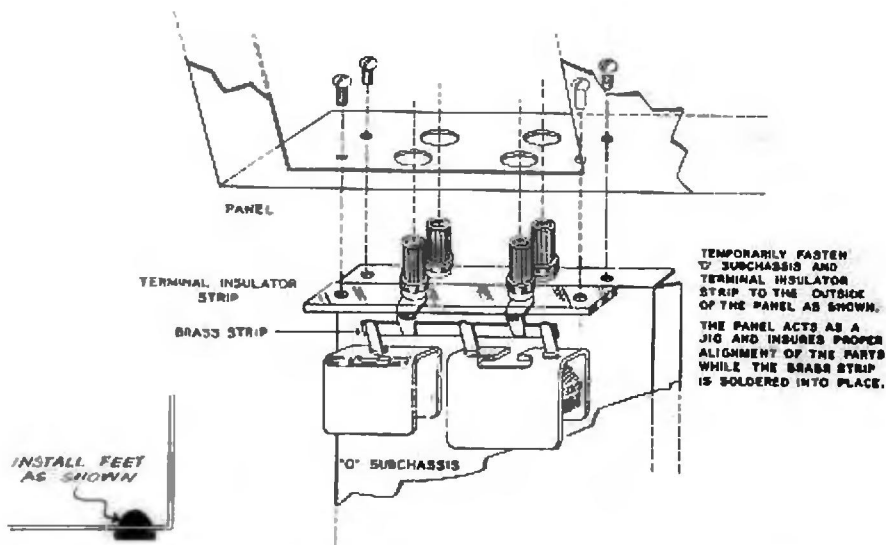

**Note:** After the tuning condensers are mounted on the "Q" sub-chassis, mount the insulated terminal strip and the sub-chassis temporarily upside down on the panel. The panel now acts as a jig and the connections between the condensers and the terminals can readily be made.

## TEST AND CALIBRATION

Check the wiring carefully before proceeding. Inspect all solder connections and make sure that no stray wires or excess solder can cause short circuits between adjacent contacts on sockets and switches.

Plug the line cord into a 117 volt 50-60 cycle AC outlet. **CAUTION:** Do not connect to a DC outlet for this will seriously damage the power transformer.

Set the CAL-Q switch to CAL and turn the SET LEVEL control clockwise. After a minute warmup observe that the level can be set to the red X1 mark on the meter. Turn the generator RANGE switch and FREQUENCY control to make sure that the X1 reading can be obtained at all frequencies.

Insert the test coil in the "L" terminals. Set the CAL-Q switch to Q and adjust the SET ZERO control for a zero reading on the meter. Set generator section to 1,000 kc and check the level by turning the switch to CAL. Switch back to Q and adjust RESONANCE control for maximum meter reading.

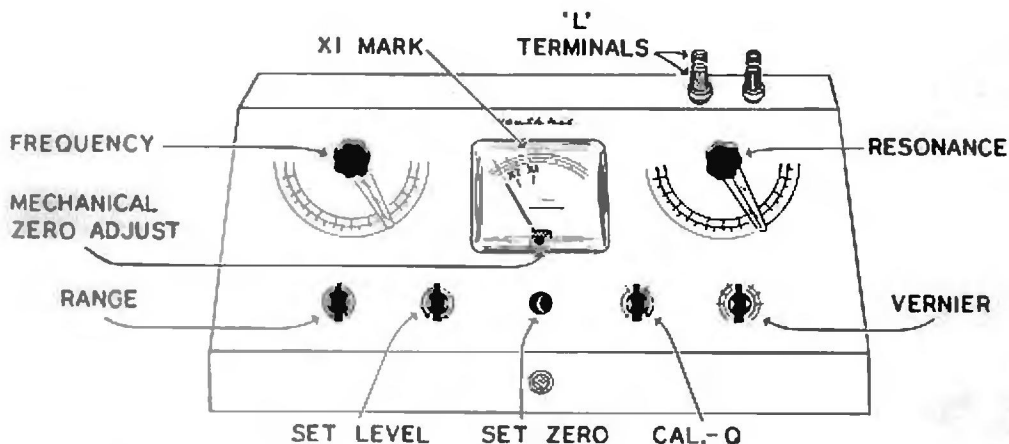

Calibrate the generator section as follows: Tune in a local broadcast station with a frequency between 1200 and 1500 kc on a receiver placed near the Q meter. Set the RANGE switch and FREQUENCY control to the same frequency as the station. With a non-metallic screw driver adjust the trimmer on the generator sub-chassis for the lowest frequency audible beat (zero beat). Now the calibration should be well within 3 percent on all four ranges. This completes the calibration of this section.

Calibrate the Q section as follows: Turn the instrument off and set the mechanical zero-adjust screw on the meter case until the pointer accurately reads zero. Turn the instrument on again. Set the generator section to 1,000 kc and adjust the level to the X1 mark. Switch to Q and turn RESONANCE control for maximum indication. With a non-metallic screw driver adjust the trimmer on the Q sub-chassis until the meter reads the Q value indicated on the test coil. Set the VERNIER to 0 and adjust the pointer on the shaft of the RESONANCE control to read on the  $C_g$  scale the capacity indicated on the test coil. This completes the calibration.

## IN CASE OF DIFFICULTY

If the instrument fails to perform as outlined in the foregoing section, proceed as follows:

1. Read the next section entitled "Principles of Operation." A thorough understanding of the circuits used may reveal the cause for difficulties.
2. Check the voltages at the tube sockets and compare them with representative readings tabulated below. Substantial deviation from the tabulated values would point to a particular portion of the circuit. Further investigation of that portion may reveal the cause.

| VOLTAGE TABLE                                      |            |             |         |           |           |
|--|------------|-------------|---------|-----------|-----------|
|  | 6X5        | OD3         | 12AT7   | 12AU7     | 6AL5      |
| 1  | NC         | T 1-4       | 0-80    | 70-90     | 0         |
| 2  | 0          | 60-80 NEG   | 0-5 NEG | 0-1.5 NEG | 0-1.5 NEG |
| 3  | 200-220 AC | Line Jumper | 0       | 4-5       | 0         |
| 4  | NC         | NC          | 0       | 0         | 4-6 AC    |
| 5  | 200-220 AC | 70-90       | 0       | 0         | 0         |
| 6  | T 140-160  | NC          | 120-150 | 70-80     | 0         |
| 7  | 5-7 AC     | Line Jumper | 0       | 0-1.5 NEG | 0-1.5 NEG |
| 8  | 180-210    | T 140-160   | 1-3     | 4-5       |           |
| 9  |            |             | 5-7 AC  | 5-7 AC    |           |
| NC means NO CONNECTION<br>T means used as tiepoint |            |             |         |           |           |

3. Have a friend check over the wiring. Wiring errors, consistently overlooked by the constructor, may be readily evident to another person.
4. Write to the Heath Company, referring to this instrument as the QM-1 "Q" meter, and describe the difficulty encountered. Include all information that may be helpful in locating the cause, such as voltage readings for instance, and we will attempt to advise you by return mail.
5. Should inspection reveal the necessity for replacement of a component, write to the Heath Company immediately. The following information should be supplied in all cases:
  - A. Thoroughly identify the part in question by using the part number and description found in the manual parts list.
  - B. Identify the type and model number of kit in which it is used.
  - C. Mention the order number and date of purchase.
  - D. Describe the nature of defect or reason for requesting replacement.

## PRINCIPLES OF OPERATION

The Heathkit Q meter operates on the principle of resonance. To obtain this resonance two conditions must be satisfied: 1. There must be a circuit capable of resonance and 2. There must be a signal to which the circuit can resonate. The signal is obtained from the generator section, and the resonant circuit comprises the Resonance condenser, the injection padder condenser and the coil under test.

To indicate resonance, a VTVM circuit is connected across the Resonance condenser. If the current flow from the generator through the injection padder is obtained from a constant current source, the voltage at resonance developed across the coil under test will be directly proportional to the Q of the circuit. Because the injection padder is much larger than the resonance condenser, practically all of the voltage across the coil appears also across the resonance condenser, where it is measured by the VTVM.

When external capacities are connected in parallel with the resonating condenser this may no longer be true and the indicated circuit Q may be much less than the actual circuit Q. (If the external capacity and the resonating condenser total 5000 MMF, the indicated Q will be half the actual Q.)

By making the injection current a constant of a particular value, the voltage developed across the coil will be a direct indication of the Q of the circuit.

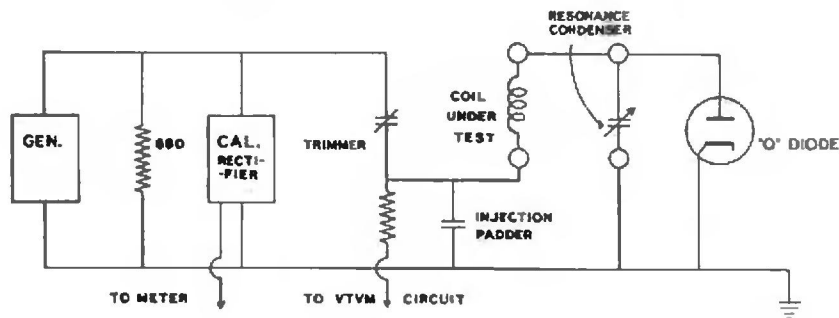

To insure a constant injection current, the output from the generator is metered to give a constant voltage. This voltage is applied to a small trimmer condenser in series with the large injection padder. The current depends practically only on the setting of the trimmer condenser and the padder current is constant. Adjustment of the trimmer during calibration correlates the meter readings of the Calibrate and VTVM sections. The relationship is independent of frequency and thus this calibration at one frequency will hold for all others.

Any losses in the resonant circuit will be reflected in a lower Q reading. In general, the losses in the coil are much greater than the losses in the other circuit elements. Thus the Q of the circuit is the Q of the coil for all practical purposes. However, for conditions involving very high Q coils and low capacity settings of the resonating condenser, this may not hold fully true, and the losses in the resonating condenser and the stray capacity reduce the indicated circuit Q below the Q of the coil itself. The effective value of the resonating condenser is used in the tests involving resonance with a coil, and is equal to the capacity of the resonating condenser in series with the injection padder.

The total capacity between the C terminals is the sum of the capacity of the resonating condenser and the stray capacities in the wiring. This value is used in capacity measurements using the substitution method.



## APPLICATIONS

The Heathkit Q Meter is an instrument that enables the technician to simulate conditions actually encountered in practical circuits, and measure the performance of the coil or condenser by itself. Such measurements are made at the operating frequency actually encountered in the practical circuits.

Thus, during the design of a broadcast receiver for instance, a loop antenna may be checked for frequency coverage and for loss of Q because of the proximity of the chassis. Various types of loop antennas may be compared by noting the Q indicated. The distributed capacity of the loop may readily be determined. The effective capacity of a tuning condenser, as well as the minimum capacity may be readily determined by substitution.

The following procedures may be used as a guide until sufficient familiarity with the instrument and its characteristics are obtained.

To measure inductance of a coil:

Set the CAL-Q switch to CAL.

Connect the coil to the L terminals.

Set the generator section to the appropriate frequency (250 kc, 790 kc, 2.5 mc or 7.9 mc) and adjust the level to X1.

Set the CAL-Q switch to Q.

Adjust the resonating condenser for maximum indication on the meter.

Read the inductance on the L scale and place the decimal point properly by referring to the inductance-frequency tabulation.

To measure the Q of a coil:

Set the CAL-Q switch to CAL.

Connect the coil to the L terminals.

Set the generator section to the desired frequency, and adjust the level to X1.

Set the CAL-Q switch to Q.

Adjust the resonating condenser accurately for maximum indication on the meter.

Read the Q value on the meter.

(If the meter reads off scale, switch to CAL. and adjust level to X2. Switch to Q and double the indicated value.)

To measure the distributed capacity of a coil:

Set the CAL-Q switch to CAL.

Connect the coil to the L terminals.

Set the resonating condenser to a convenient small value such as 100 MMF ( $C_E$  scale). Note this value as  $C_A$ .

Set the CAL-Q switch to Q and adjust the generator section to give a maximum indication.

Note the generator frequency.

Set the generator to a new frequency equal to half the old frequency.

Switch to CAL and check the level.

Switch back to Q and adjust the resonating condenser to give a maximum indication.

Note the value on the  $C_E$  scale and call this value  $C_B$ .

The distributed capacity is readily calculated from

$$C_D = \frac{C_B - 4C_A}{3}$$

Note: While this method is not completely accurate, it will suffice in most cases. The accuracy may be increased by repeating the measurement with different values of  $C_A$  and averaging the results.



To measure a capacity of 425 MMF or less:

Set the CAL-Q switch to CAL.

Connect a test coil to the L terminals.

Connect the unknown condenser to the C terminals.

Set the resonating condenser to a small value (50 MMF for instance). Note this value as  $C_A$ .

Switch to Q and adjust the generator section for maximum indication.

Switch to CAL and remove the unknown condenser.

Switch to Q and adjust the resonating condenser for maximum indication.

Note the reading on the  $C_T$  scale as  $C_B$ .

The unknown capacity is readily calculated from

$$C_X = C_B - C_A$$

Note: For very small capacities, the vernier dial may be used instead of the main dial.

To measure a capacity larger than 425 MMF:

Set CAL-Q switch to CAL.

Connect a test coil of known inductance to the L terminals.

Connect the unknown condenser to the C terminals.

Switch to Q and adjust the generator for maximum reading.

Note the capacity on the  $C_T$  scale as  $C_A$ .

Note the generator frequency as  $f$ .

Using the inductance of the test coil as  $L$ , calculate the resonating capacity  $C_B$  from

$$C_B = \frac{1}{6.28^2 f^2 L}$$

This value  $C_B$  is made up of three parts:  $C_A$  in parallel with the unknown capacity  $C_X$  and the two in series with the 5000 MMF injection padder. The unknown is calculated from

$$C_X = \frac{5000 C_B}{5000 - C_B} - C_A$$

#### SERVICE

In event continued operational difficulties of the completed instrument are experienced, may we remind you that the facilities of the Heath Company Service Department are at your disposal. Your instrument may be returned for inspection and repair for a service charge of \$5.00 plus the cost of any additional material that may be required. THIS SERVICE POLICY APPLIES ONLY TO COMPLETED INSTRUMENTS CONSTRUCTED IN ACCORDANCE WITH THE INSTRUCTIONS AS STATED IN THE MANUAL. Instruments that are not completed or instruments that are modified will not be accepted for repair. Instruments showing evidence of acid core solder or paste fluxes will be returned NOT repaired.

The Heath Company is willing to offer its utmost cooperation to assist you in obtaining the proper operation of your instrument and therefore the factory repair service is available for a period of one year from the date of purchase.

NOTE: Before returning this unit, be sure that all parts are securely mounted. Attach a tag to the instrument, giving name, address and trouble experienced. Pack in a rugged container, preferably wood, using at least three inches of shredded newspaper or excelsior on all sides. Do not ship in the original kit carton as this carton is not considered adequate for safe shipment of the completed instrument. Ship by prepaid express, if possible. Return shipment will be made by express collect. Note that a carrier cannot be held liable for damages in transit if PACKING IN HIS OPINION is insufficient.

Prices are subject to change without notice. The Heath Company reserves the right to change the design of this instrument without incurring liability for equipment previously supplied.

## WARRANTY

The Heath Company limits its warranty of any parts supplied with any Heathkit (except tubes, meters and rectifiers, where the original manufacturer's guarantee only applies) to the replacement within three (3) months of said part, which when returned with prior permission, postpaid, was, in the judgment of the Heath Company, defective at the time of sale.

The assembler is urged to follow the instructions exactly as provided. The Heath Company assumes no responsibility or liability for any damages or injuries sustained in the assembly of the device or in the operation of the completed instrument.

HEATH COMPANY  
Benton Harbor, Michigan

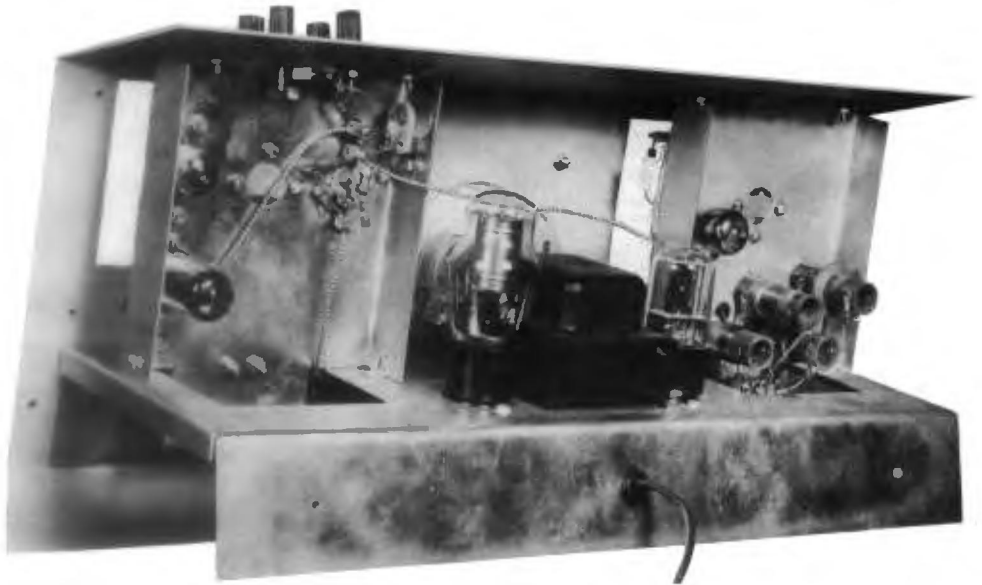

## PARTS LIST

| Part No.                            | Parts Per Kit | Description         | Part No.                 | Parts Per Kit | Description                   |
|-------------------------------------|---------------|---------------------|--------------------------|---------------|-------------------------------|
| <b>Resistors</b>                    |               |                     | <b>Sockets—Terminals</b> |               |                               |
| 1-6                                 | 1             | 470 Ohms            | 434-2                    | 2             | Octal sockets                 |
| 1-7                                 | 1             | 680 Ohms            | 434-16                   | 2             | Noval 9-pin sockets           |
| 1-44                                | 3             | 2200 Ohms           | 434-34                   | 1             | Miniature 7-pin socket        |
| 1-22                                | 1             | 22K Ohms            | 427-2                    | 4             | Terminal bases                |
| 1-25                                | 1             | 47K Ohms            | 100-M16                  | 4             | Terminal caps                 |
| 1-2F                                | 1             | 100K Ohms           | 75-9                     | 1             | Terminal insulator strip      |
| 1-38                                | 4             | 3.3 Meg. Ohms       | 431-1                    | 1             | 1-lug terminal strip          |
| 1-41A                               | 1             | 5.6 Ohm 1 watt      | 431-3                    | 1             | 3-lug terminal strip          |
| 1-14F                               | 1             | 1500 Ohm 2 watt     | 431-5                    | 2             | 4-lug terminal strips         |
| 1-2B                                | 1             | 4700 Ohm 2 watt     |                          |               |                               |
| 3-1E                                | 1             | 2500 Ohm 5 watt     |                          |               |                               |
| <b>Controls</b>                     |               |                     | <b>Meter—Tubes—Lamp</b>  |               |                               |
| 11-9                                | 1             | 3000 Ohms w.w.      | 407-17                   | 1             | 50 microamp. meter            |
| 19-2                                | 1             | 10K Ohms w. switch  | 411-17                   | 1             | 6X5 tube                      |
|                                     |               |                     | 411-24                   | 1             | 12AT7 tube                    |
|                                     |               |                     | 411-25                   | 1             | 12AU7 tube                    |
|                                     |               |                     | 411-32                   | 1             | OD3/VR150 tube                |
|                                     |               |                     | 411-40                   | 1             | 6AL5 tube                     |
|                                     |               |                     | 412-1                    | 1             | 447 lamp                      |
| <b>Condensers</b>                   |               |                     | <b>Metal Parts</b>       |               |                               |
| 20-26                               | 1             | 5000 MMF special    | 90-16                    | 1             | Cabinet                       |
| 21-11                               | 1             | 150 MMF             | 100-M19                  | 2             | Dial drive pulleys            |
| 21-14                               | 4             | 1000 MMF            | 200-M40                  | 1             | Chassis                       |
| 21-15                               | 2             | 5000 MMF            | 200-M41                  | 1             | Gen. subchassis               |
| 25-3                                | 1             | 8 - 8 MFD 450 volt  | 200-M42                  | 1             | "Q" subchassis                |
| 26-11                               | 2             | 450 MMF tuning      | 203-M41F31               | 1             | Panel                         |
| 26-12                               | 1             | 7 MMF tuning        | 204-M42                  | 1             | Drive Shaft bracket           |
| 31-7                                | 1             | 2.5-8 MMF           | 205-M17F33               | 1             | Gen. dial plate               |
| 31-5                                | 1             | 7-35 MMF            | 205-M17F34               | 1             | "Q" dial plate                |
|                                     |               |                     | 453-M6                   | 1             | Drive shaft                   |
| <b>Cotts</b>                        |               |                     | <b>Hardware</b>          |               |                               |
| 40-11                               | 1             | Band "A" coil       | 250-2                    | 6             | 3-48 screws                   |
| 40-12                               | 1             | Band "B" coil       | 250-7                    | 17            | 6-32 x 5/16 screws            |
| 40-13                               | 1             | Band "C" coil       | 250-8                    | 17            | #6 x 3/8 Sheet metal screws   |
| 40-14                               | 1             | Band "D" coil       | 250-9                    | 18            | 6-32 x 3/8 screws             |
| 40-23                               | 1             | Test coil           | 250-15                   | 2             | 8-32 x 1/8 pointer set screws |
|                                     |               |                     | 250-16                   | 2             | 8-32 x 3/16 pulley set screws |
|                                     |               |                     | 250-22                   | 4             | 8-32 knob set screws          |
|                                     |               |                     | 252-1                    | 6             | 3-48 nuts                     |
|                                     |               |                     | 252-3                    | 33            | 6-32 nuts                     |
|                                     |               |                     | 252-4                    | 2             | 8-32 nuts                     |
|                                     |               |                     | 252-7                    | 4             | Control nuts                  |
|                                     |               |                     | 253-1                    | 1             | #6 flat fiber washer          |
|                                     |               |                     | 253-2                    | 1             | #6 Fiber shoulder washer      |
|                                     |               |                     | 253-10                   | 3             | Control nickel washers        |
|                                     |               |                     | 253-11                   | 1             | "E" washer                    |
|                                     |               |                     | 254-1                    | 37            | #6 lockwashers (Int.)         |
|                                     |               |                     | 254-2                    | 2             | #8 lockwashers                |
|                                     |               |                     | 254-5                    | 4             | Control lockwashers           |
|                                     |               |                     | 254-6                    | 4             | #6 lockwashers (ext.)         |
|                                     |               |                     | 254-7                    | 6             | #3 lockwashers                |
|                                     |               |                     | 259-1                    | 9             | #6 solder lugs                |
|                                     |               |                     | 73-1                     | 2             | 3/8 rubber grommets           |
|                                     |               |                     | 204-9                    | 4             | Angle brackets                |
|                                     |               |                     | 258-1                    | 1             | Dial cord spring              |
|                                     |               |                     | 261-1                    | 4             | Rubber feet                   |
| <b>Transformer—Crystal—Switches</b> |               |                     |                          |               |                               |
| 54-5                                | 1             | Power transformer   |                          |               |                               |
| 56-1                                | 1             | Crystal diode       |                          |               |                               |
| 63-48                               | 1             | 4-position switch   |                          |               |                               |
| 63-49                               | 1             | DPDT—NS switch      |                          |               |                               |
| <b>Wire</b>                         |               |                     |                          |               |                               |
| 89-1                                | 1             | Line cord           |                          |               |                               |
| 212-M2                              | 1             | Brass strip         |                          |               |                               |
| 340-3                               | 1             | Length bare wire    |                          |               |                               |
| 344-1                               | 1             | Length hookup wire  |                          |               |                               |
| 346-1                               | 1             | Length sleeving     |                          |               |                               |
| 349-1                               | 1             | Length dial cord    |                          |               |                               |
| <b>Knobs—Pilot light parts</b>      |               |                     |                          |               |                               |
| 462-4                               | 1             | Acorn knob          |                          |               |                               |
| 462-6                               | 2             | Tuning knobs        |                          |               |                               |
| 462-M11                             | 4             | Pointer knobs       |                          |               |                               |
| 100-M10                             | 2             | Dial pointers       |                          |               |                               |
| 252-12                              | 1             | Pilot light nut     |                          |               |                               |
| 413-1                               | 1             | Pilot light jewel   |                          |               |                               |
| 434-22                              | 1             | Pilot light socket  |                          |               |                               |
| 455-1                               | 1             | Pilot light bushing |                          |               |                               |

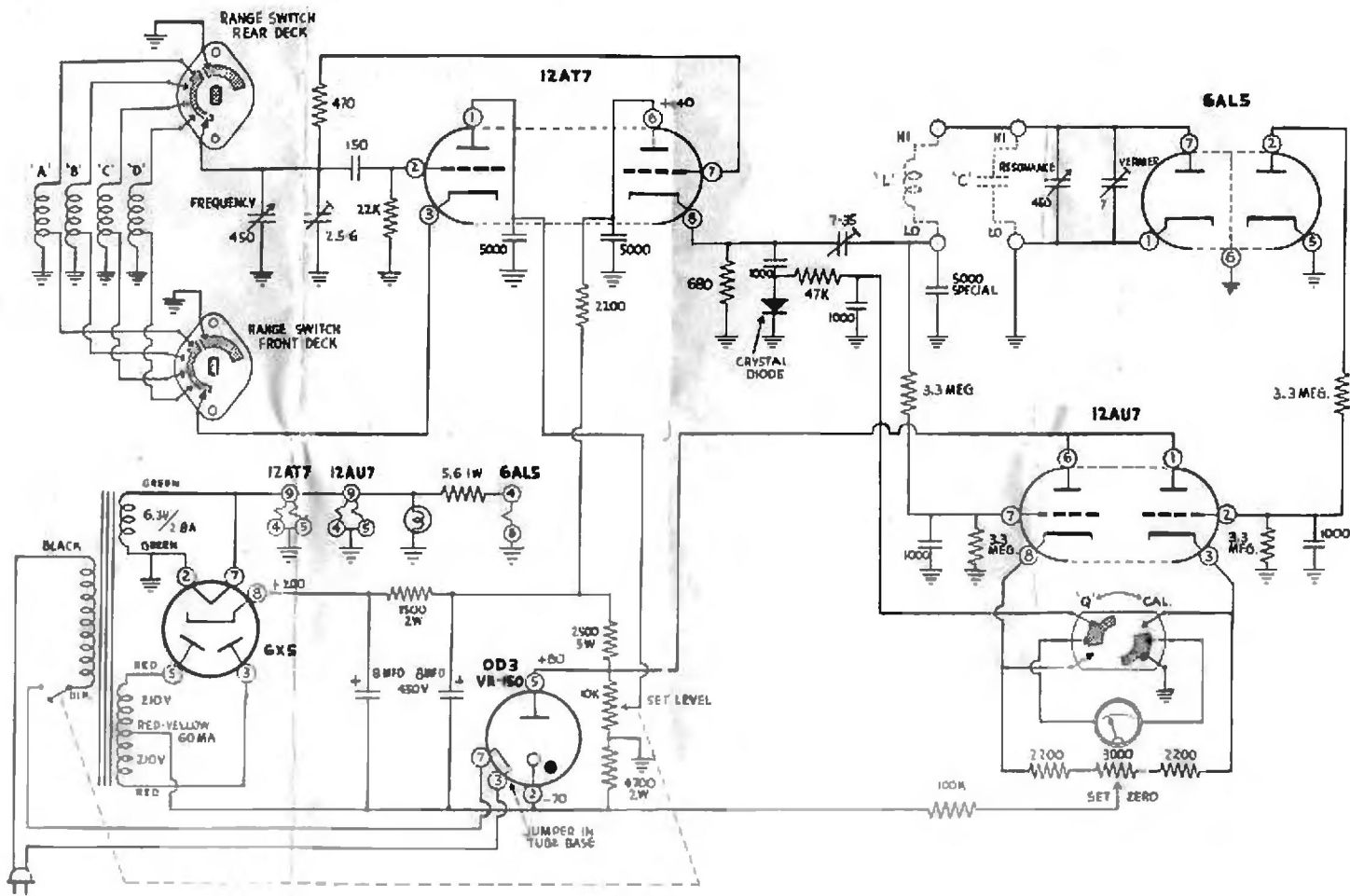

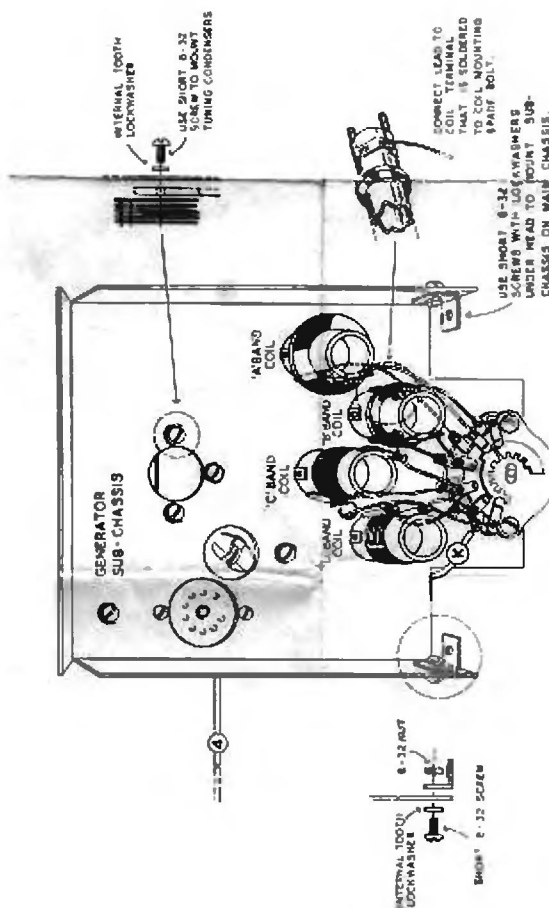
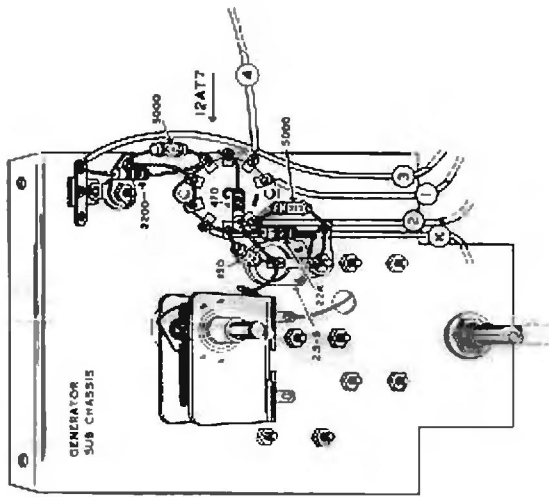

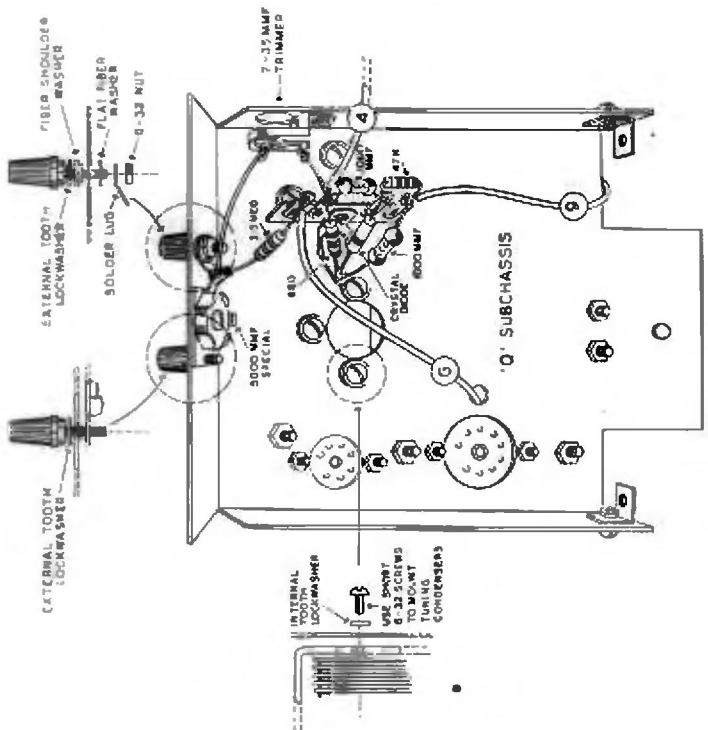
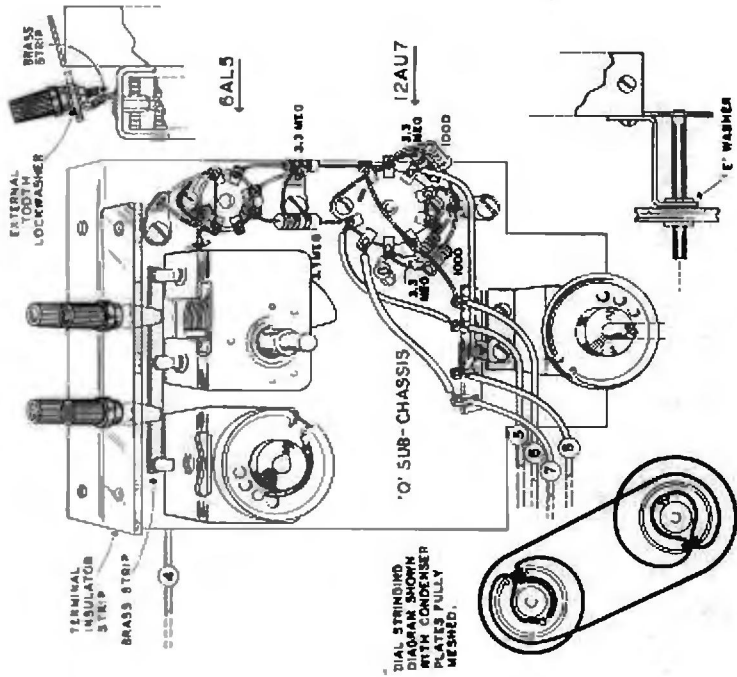

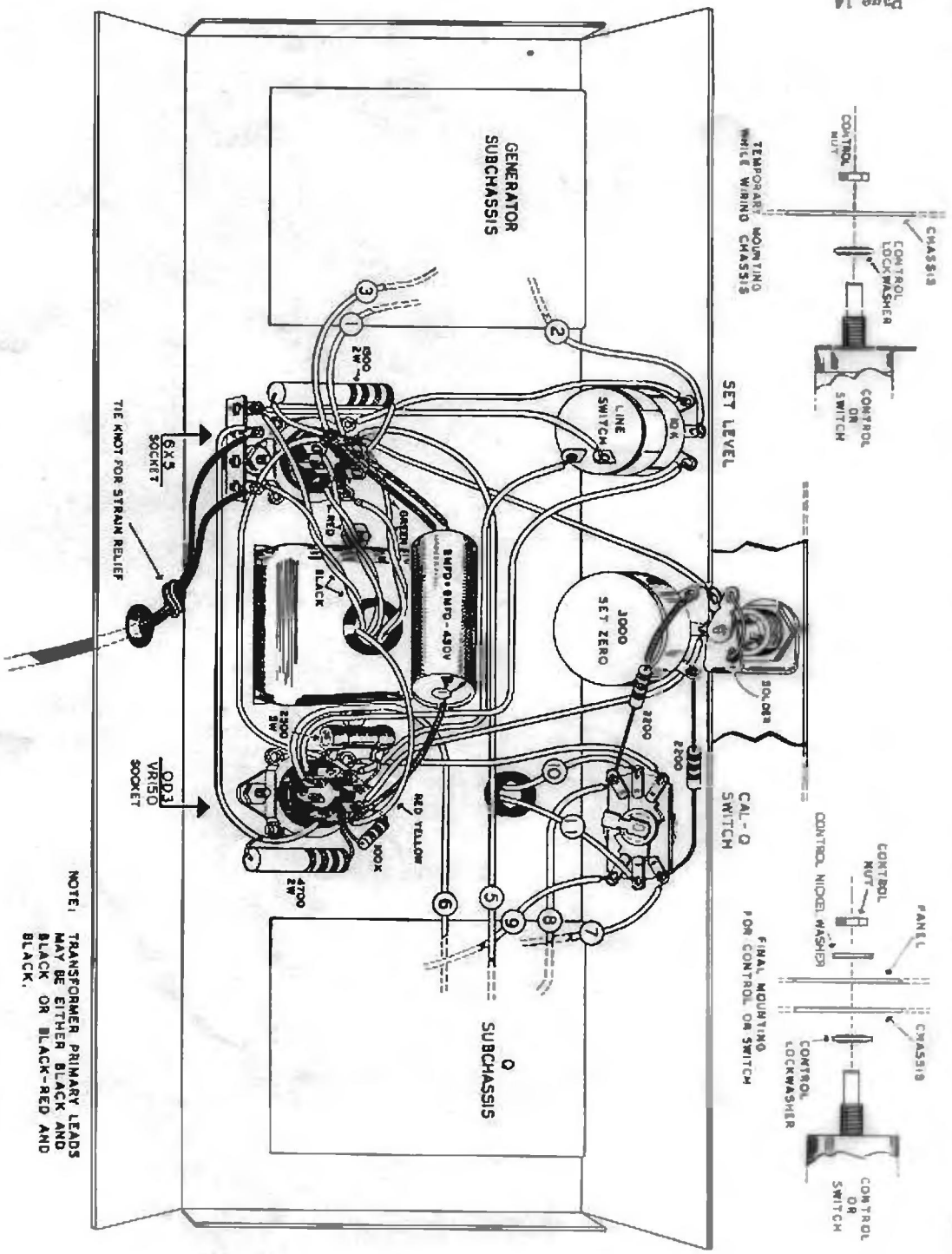



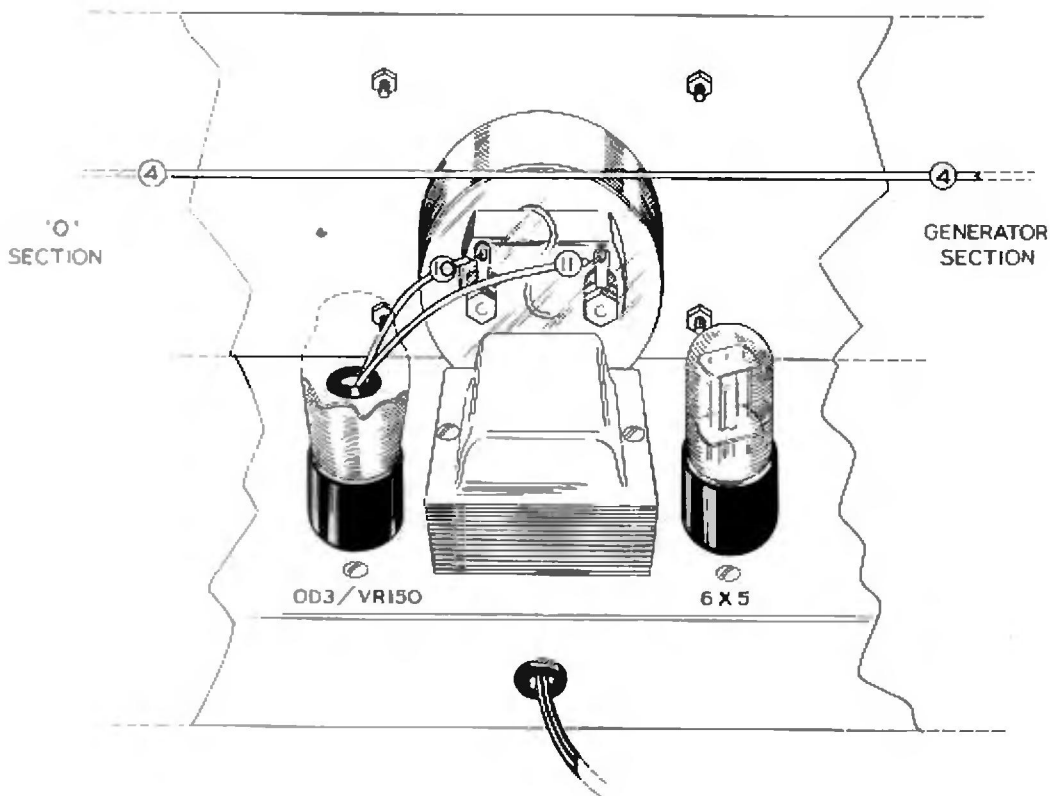

**WIRING OF EXPORT TYPE  
110/220 VOLT POWER  
TRANSFORMERS**

These transformers have a dual primary for use on either 110 Volts or 220 Volts.  
Wire as shown.

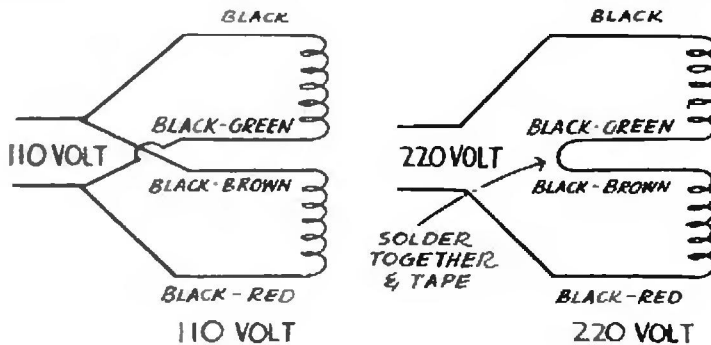

**HEATH COMPANY**  
**BENTON HARBOR, MICHIGAN**

THE WORLD'S  
*Finest*  
TEST EQUIPMENT  
IN KIT FORM